

Varenummer: 204380M1675D0U

Beskrivelse: E+G Justerfod  
GN 43-80-M16-75-D0-U

Note: U Uden møtrik, sekskant i toppen, spændeflade i bunden

## Mål

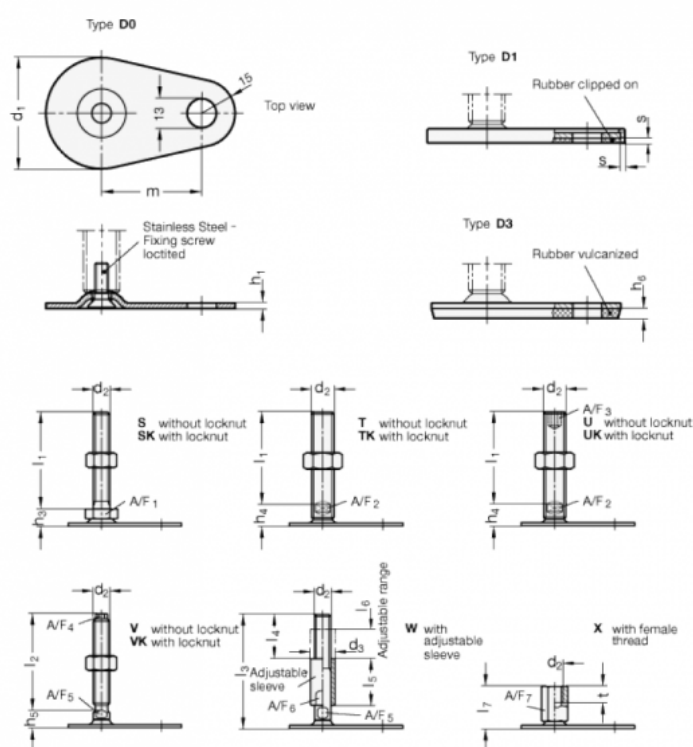

A/F2 = 12	m = 70
A/F3 = 8	s =
d1 = 80	
d2 = M16	
h1 = 3	
h4 = 18	
h6 =	
l1 = 75	